

VISOFOLD 6000 Aluminium Bi-fold Doors

Please tick: Order [] Quote []
New Build [] Replacement/Extension [] Doc Q compliant []

YOUR CONTACT DETAILS

Company Name: _____
Address: _____

Postcode: _____
Tel: _____ Fax: _____
Delivery Address: _____

Postcode: _____

Date required:

Your ref/order No.:

OPENING CONFIGURATION

Inward [] Outward []

DELIVERY OPTION

Fully assembled []
Kit form (must be if over 5100mm) []
Glazed (full spec inc spacer bar colour) []
Unglazed []

SASH OPTION (see overleaf for details)

Standard []
Heritage type (dummy transom available) []

BOTTOM TRACK DETAIL (see overleaf for details)

Standard outer frame 55mm []
175mm Integrated cill/threshold []

DRAINAGE REQUIRED

Concealed []
None (only if internal door) []

SINGLE COLOUR

White [] Other []
RAL No.:

DUAL COLOUR

Internal RAL No.: External RAL No.:

FRAME SIZES

Width (mm)
Height (mm)

Note: You must allow 10mm tolerance between frame and opening size

CILL Included in overall frame height (cill height is 25mm)

150mm [] 16mm Drainage tray []
190mm [] No cill (only if internal door) []

HINGE COLOUR (inc. D-HANDLE)

White [] Colour Matched []
Black [] Black (with chrome D) []

MAIN HANDLE COLOUR

White [] Black [] Chrome []
Gold [] Satin Silver [] Colour Matched []
Brushed Silver L/L (Hoppe) []
Brushed Silver separate handle & escutcheon VBH []

HEAD PACKER

42mm []
Included in height []

SHOOTBOLT HANDLE

Standard []
Flush [] (must be flush if you have an even amount of doors
all sliding one way - outside access not available)

TRICKLE VENTS (in 42mm head packer)

Yes [] *Please draw position on grid*
Quantity 1 [] 2 [] 3 []

SHOOTBOLT HANDLE COLOUR

Chrome [] Colour Matched []

White [] Black [] Chrome []
Brushed Silver [] Colour Matched [] Gold []

Clearly mark on the grid shown the configuration required. The elevation of the door is as viewed from the outside. Mark along the arrows the direction that each panel has to travel.

If you have 2 swing panels, indicate on this drawing which panel you would like to open first (with "FIRST")

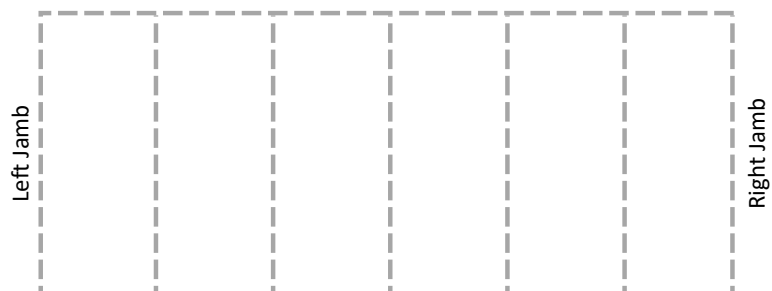

Maximum sash size 1000mm x 2200mm
Minimum recommended sash size 700mm x 1775mm

DV614
Outer Frame
82

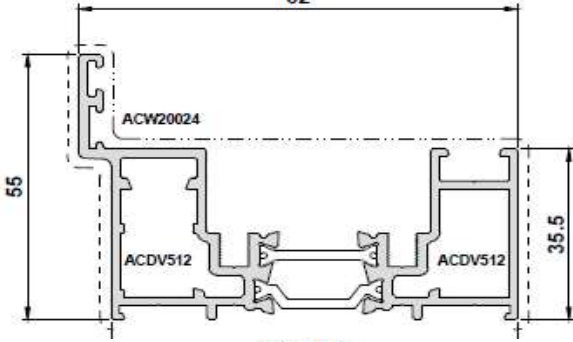

DV617
Flat Outer Frame
82

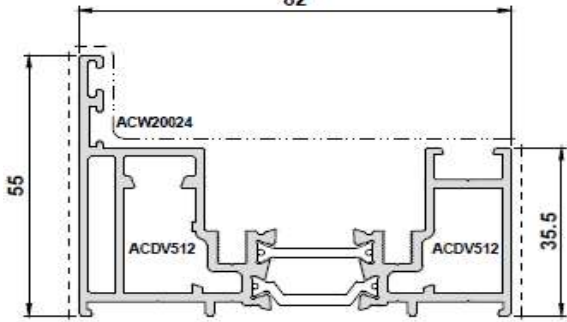

DV676

Cill Threshold

Use With DV617 ONLY

OPEN OUT ONLY

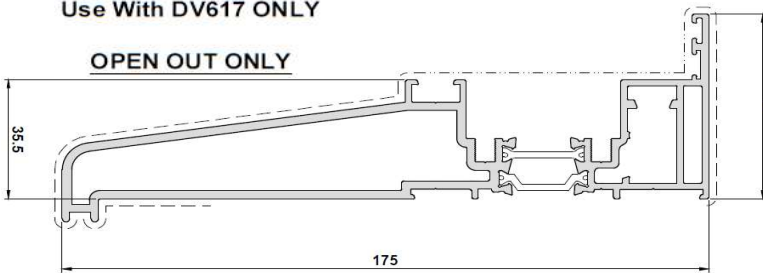

DV622
Square Bi-Fold Sash

STANDARD SASH

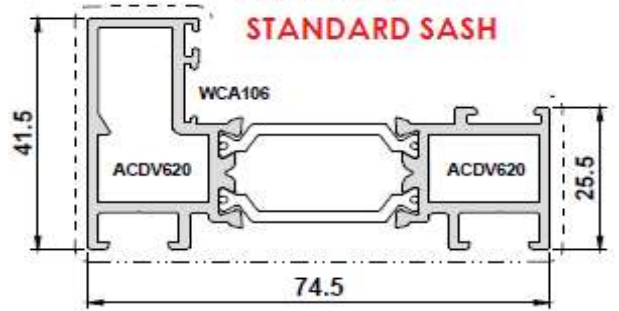

Heritage Bi-Fold Sash

HERITAGE SASH

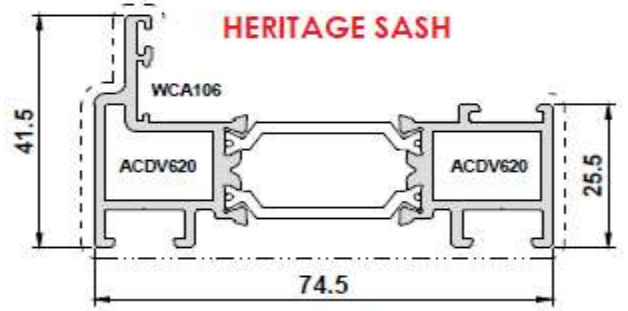

DV634

Heritage Bi-Fold Transom

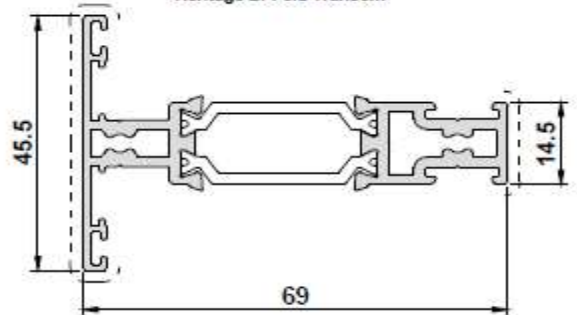

ETC157

150mm Concealed Drainage Cill

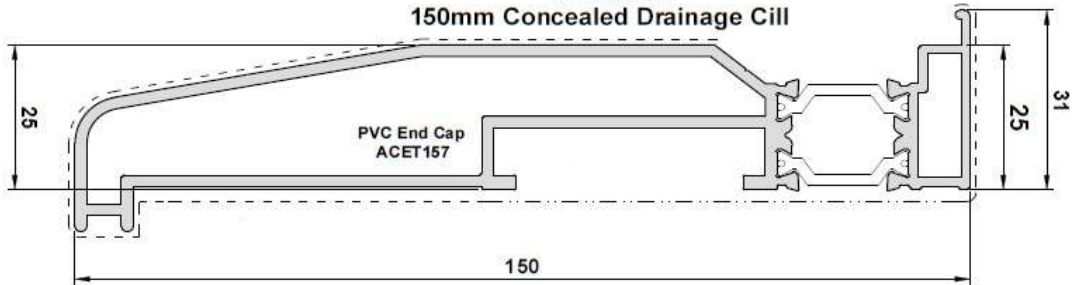

ETC158

190mm Concealed Drainage Cill

